



BILLIB

THE CLOCK SPECIALISTS
ESTABLISHED 1969

Instruction and Care *Manual*

floor clocks

cks

For you, the Tradition begins now.

The BilliB story began in 1969 when William Dawe began building a clock company in Winchester with a handful of likeminded colleagues with a belief in quality.

In the years that followed, BilliB became known for their fine craftsmanship and untiring attention to detail. These things became tradition at BilliB.

BilliB Clocks are the result of the skills of four generations of master craftsmen creating the finest clock cabinetry combined with the time-honoured skills of the master clock movement makers from the Black Forest region of Germany.

A BilliB Clock is a marvellous timepiece that is much more than just a keeper of time. It is something special that will become part of the owner’s home and reflect the character of the owner’s family.

And, with care, it will endure and bring enjoyment and the pride of ownership to future generations.

For you, the tradition begins now.

Table of Contents

Unpack	3
Position & Level Clock	3
Access to Mechanism	3, 4
Hang Pendulum	4
Hang Chime Tubes	4
Hang Weights	5
Set Time	5
Select Chimes	6
Silence Chimes	6
Adjust Hammers	6, 7
Set Moon & Calendar Dial	7
Wind Clock	8
Regulate Clock	9
Chime History	10
Care of Clock	12
Troubleshooting	14
Warranty	16, 17

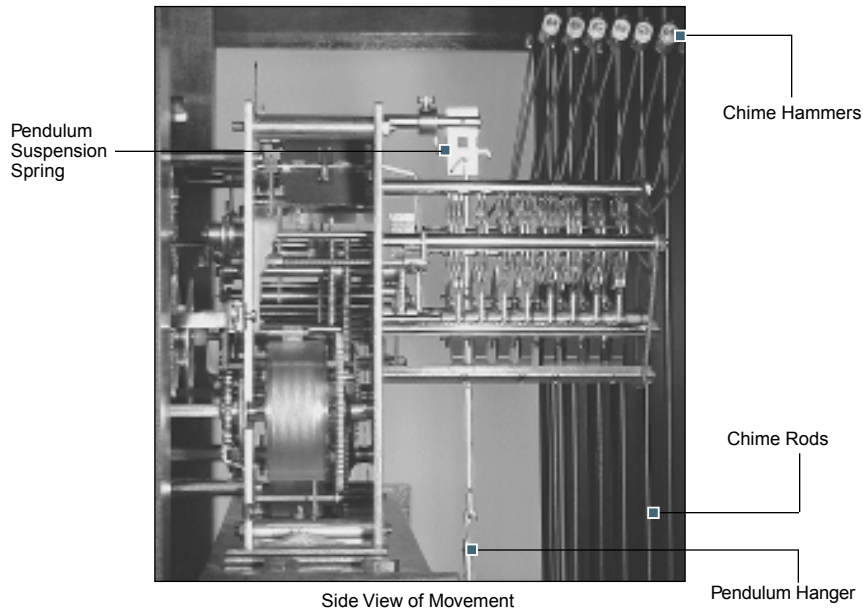
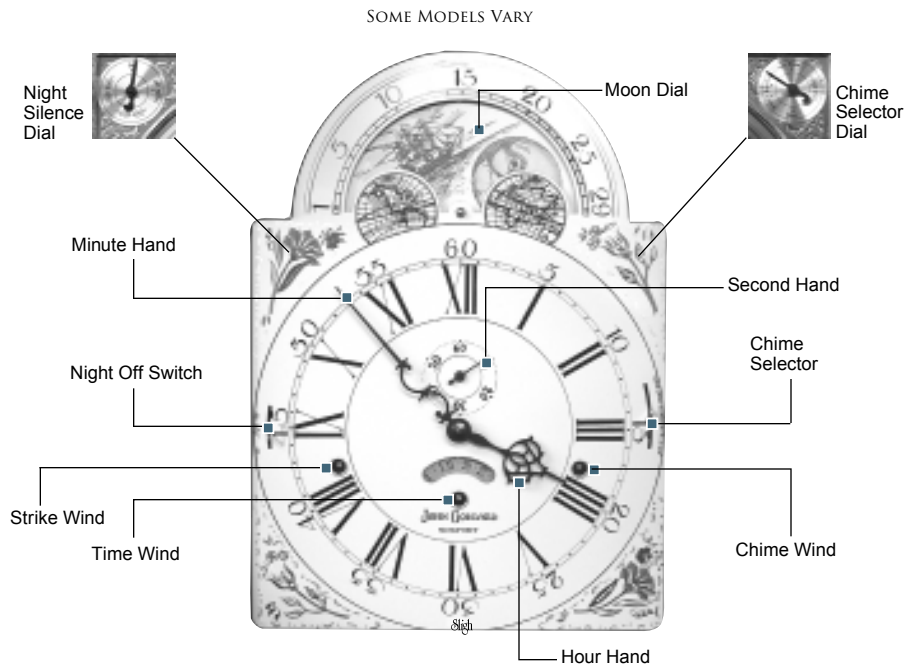

Setting Up Your Clock

1. Unpack

Remove contents from master carton:

Pendulum - may be fastened to carton, or inside of clock cabinet (Fig. 1).

Clock - Remove protective plastic bag.

Parts Box - located under clock; may contain cabinet key, winding crank or winding key, weights and a level, depending on model.

Optional Parts may be packaged separately, located above or below clock. Make sure finials, glass shelves, side panels and other optional parts are removed before discarding the master carton (Fig. 1).

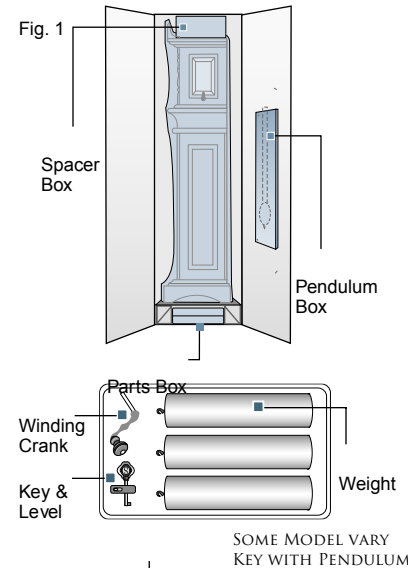

2. Position and Level Clock

Position your clock in its final location, avoiding direct sunlight, heating/air conditioning vents, heavy traffic and play areas.

Your clock must rest in a level and stable position. Turn the levelling glides if fitted at the base of the clock (Fig. 2) to raise or lower each corner of the clock. Check your adjustments using a spirit level.

See Troubleshooting for optional deep carpet glides or hard board.

If a safety strap is provided, secure the free end of the strap to a wall using one of the methods diagrammed in Fig. 3.

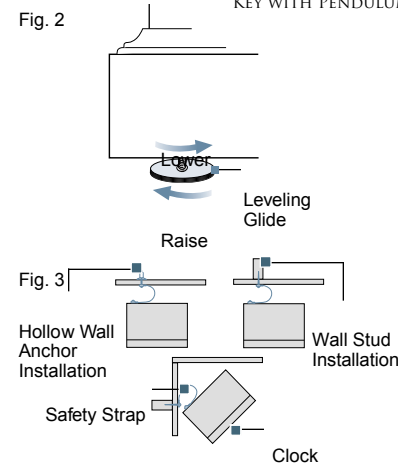

3. Access Clock Mechanism

NOTE: Use gloves or clean, soft cloth when handling brass fixtures to avoid tarnishing.

There are 5 mechanism access options:

Side Doors (Fig. 4a)

Side Panels are held in place by a small turn button located near the inside lower edge of the side panel (Fig.4a). To remove, lift panels up and push into body of clock. Tilt and remove panel through side opening.

Lower Front Door (Fig. 4a)

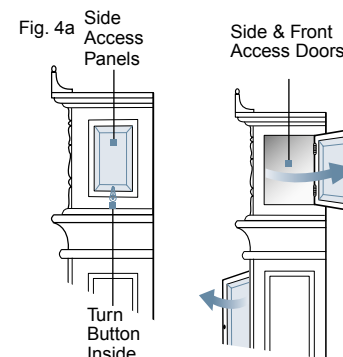

Removable Hood (top of clock). To remove, rotate the turn buttons and slide hood forward tilting

slightly to clear dial frame.

Access Panel located on back of clock.

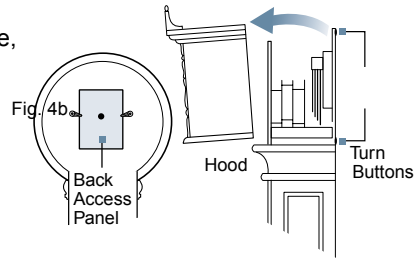

4. Remove Packaging

Models Vary but principals remain the same.

Carefully remove staples and retainer cardboard from chime rods Cut rubber band and remove foam blocks used to secure the chime hammers (Fig. 5).

DO NOT remove foam blocks from the weight pulleys at this time (Fig. 9, page 5).

In some clocks, pendulum and chains are packed inside the clock cabinet (Fig. 6). Remove string used to secure chain and pendulum to eyelet screws. Remove eyelet screws after pendulum and chains have been detached.

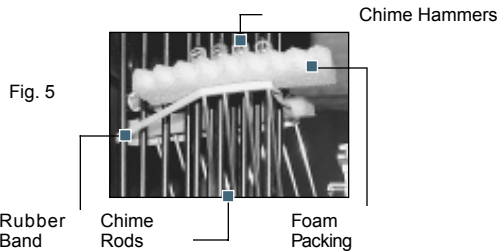

5. Hang Chime Tubes

Select models only. The chime tubes are hung over the buttons on the back of the chime tube rack. Tubes are hung with the longest tube on the left, as you face the clock; the shortest on the right. Install each tube through the front door and hang on appropriate button (Fig. 7).

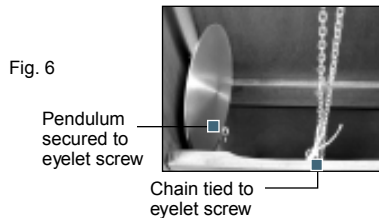

6. Hang Pendulum

Some pendulum bobs have a protective plastic coating which should be removed. Carefully hook the pendulum onto the pendulum hanger as diagrammed (Fig. 8).

NOTE: Take care not to twist the hanger, which may cause the delicate suspension spring to break.

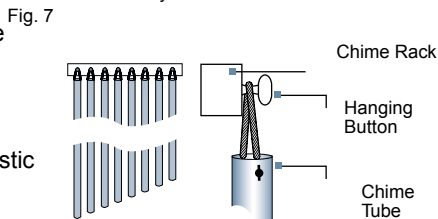

Fig. 8

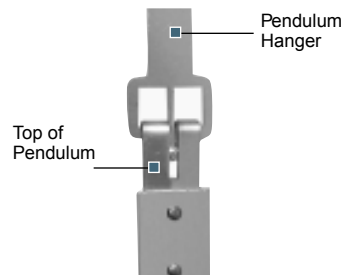

Fig. 9



7. Hang Weights

Make sure weight hooks are screwed tightly to the top of each weight prior to hanging. With foam blocks still in place attach weights to pulleys, or in some clocks, chains. Weights are labeled on the bottom L (Left) R (Right) and C (Centre). Place weights onto the left, right and centre chains/pulleys as you face the clock front (Fig. 9). Some models will have only two weights.

Fig. 10



NOTE: Let clock run 24 hours and lift foam blocks from between cables if fitted (Fig. 10).

8. Start Clock

Once clock is level and weights are hung, draw pendulum over to one side of the case and release it (Fig. 11). As pendulum slows down to its normal swing, the movement will automatically adjust to the proper beat. The sound should be an even tempo: Tick—Tick—Tick—Tick. If the sound is uneven, the beat is out of adjustment. Stop pendulum and restart the swing. If the beat is improved, but not yet even, repeat the process but pull the pendulum to the other side of the case. The movement will go out of beat if the clock is not level.

Fig. 11

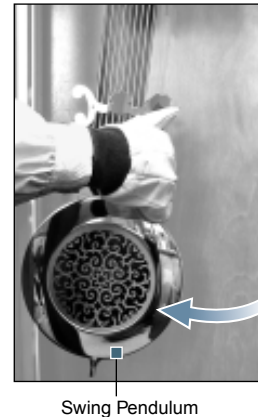

9. Set Time

DO NOT move the clock hands while chimes are playing.

To set your clock, move the minute hand clockwise, the chimes should not play. If for some reason the chimes should begin to play when setting the clock, pause until they complete themselves before continuing. Wait until chimes stop, and turn the minute hand clockwise to the desired time (Fig. 12).

Fig. 12



DO NOT move the hour hand, it will automatically adjust as the minute hand is turned.

NOTE: If hour hand does not coincide with chime, see Troubleshooting page 15.

10. Select Chimes

DO NOT adjust chime selectors while chimes are playing.

Most clocks are equipped with a chime selector and silencer lever at the 3:00 position or a silencer dial in the upper right-hand corner of the clock. Slide the lever up or down or turn the dial to the desired position. These positions may not correspond exactly with the markings on the clock. Your clock may also be equipped with a selector lever at the 9:00 position or selector dial in the upper left-hand corner (Fig. 13a). This lever controls the automatic night silencer, which silences the chimes and strike during the nighttime hours

11. To Silence Chimes

Some BilliB clocks are equipped with a lever located inside the lower cabinet of the clock and hangs in front of the right-hand weight. You may need to reach up into the cabinet to locate the end of the lever. Push up on the lever to turn on chime function, pull down to silence chimes (Fig. 13b).

Depending on model, your clock will chime every quarter hour and gong for each hour, on the hour. Some clock styles only chime on hour and half-hour increments.

12. Adjust Chime Hammers

The tone of your chime is affected by the hammer positions. The hammers are set at the factory, however, it is possible that they can go out of adjustment. If the hammers do not strike the rods or bell correctly, bend the hammer shafts slightly. The hammer heads, while at rest, should be approximately $\frac{1}{16}$ " to $\frac{1}{8}$ " from the rods or bell (Fig. 14). If it is too close, the note will sound twice or sound dull. If too far away, the note will be soft or fail to sound at all.

Fig. 13a

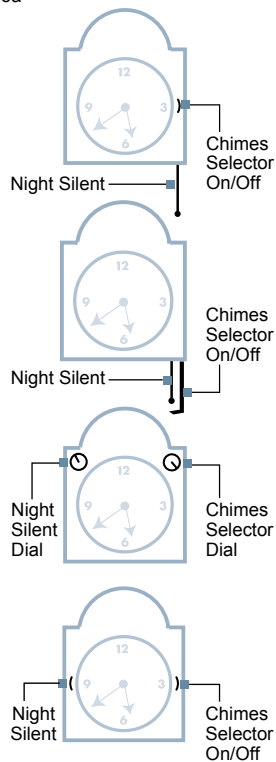

Fig. 13b

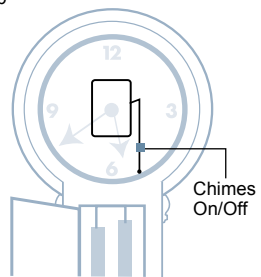

Fig. 14

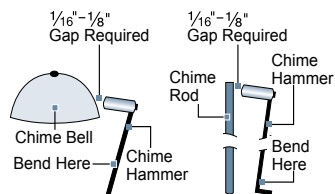
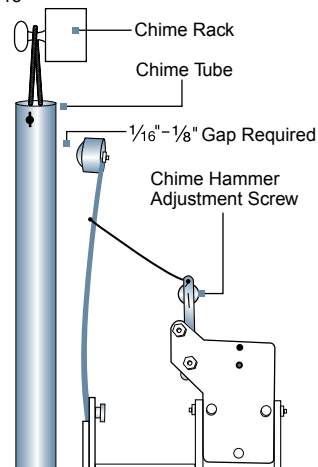

Fig. 15



In tubular chime clocks, hammer adjustments are made by tuning small screws on the end of each hammer draw rod at the clock mechanism (Fig. 15). By tuning these screws, the hammer heads can be brought into proper location with the tubes. The hammer heads, while at rest, should be approximately $\frac{1}{16}$ " to $\frac{1}{8}$ " from the chime tubes.

13. Set Moon Dial

If your clock has the moon phase dial feature, follow these instructions.

CAUTION: If the moon does not move easily, it is probably in the process of advancing. Wait several hours, or set the clock several hours ahead, and then try again.

Use a calendar to look up the date of the last full moon. Count the number of days, including today, since the last full moon.

Apply slight pressure to the face of the moon dial with your hand and rotate clockwise until the moon is directly below the #15 (Fig. 16).

Turn the moon dial clockwise one "click" for everyday since the last full moon.

The moon dial is now set and will continue to operate unless the clock stops. The moon dial may be reset when the clock is started.

Fig. 16



Setting Moon Dial

14. Set Calendar Dial

Some clocks have a calendar dial (Fig. 17). Insert a pointed object into one of the setting holes, located above each date, and turn dial. The calendar can be set to coincide with the current date, but will need to be advanced at the end of any months having less than 31 days.

NOTE: If your calendar changes at noon instead of midnight, reset clock 12 hours ahead or back.

Fig. 17

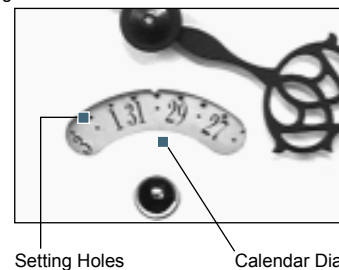

BILLIB

15. Wind Clock

Crank Key Wind

Your clock should be wound once a week or before weights have finished descending. If you turn the chimes to silent, the outer weights will not descend. To wind the clock, insert the winding crank (Fig. 18) into each of the holes in the dial. Turn the crank to wind the clock. The clock is equipped with an automatic limit device, which prevents weights from being raised too far. When winding, take extra care to prevent cables from crossing. If weights reach the bottom of the clock, make sure they are not tipped forward or backwards when you begin winding the clock. Wind slowly, do not allow the weights to sway.

DO NOT hold the weights as you wind, use only the crank.

DO NOT wind the clock without the weights on the pulleys.

Chain Wind

Your clock should be wound once a week or before the weights have finished descending. To raise the weights, slowly pull the chain straight down with one hand while guiding the weight and chain with the other hand (Fig. 19). If you pull too fast, the weight may touch the seat of the movement and cause damage to the chain as well as the movement.

DO NOT push up on weights as you wind.

DO NOT pull up on the chains without the weights attached.

NOTE: IF YOU TURN THE CHIMES TO SILENT - on clocks with three weights the outer weights will not descend and on clocks with two weights the weight to your left, as you face the clock, will not descend. See Troubleshooting page 15.

Fig. 18

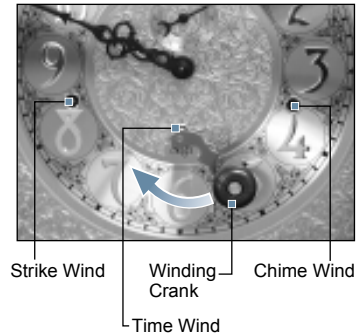
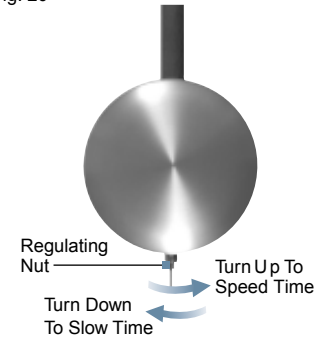

Fig. 19



BILLIB

Fig. 20



16. Adjust/Regulate Clock

To adjust the timekeeping on your clock, turn the regulating nut under the pendulum bob up to speed the swing of the pendulum, turn down to slow the pendulum (Fig. 20).

Hold pendulum with one hand while adjusting the regulating nut with the other.

DO NOT allow pendulum to twist. This may damage the suspension spring (Fig. 21).

One complete turn of the regulating nut will affect approximately one half minute in 24 hours. Seasonal temperature changes may require adjustments to the regulating nut. Reset clock hands after adjustment.

BILLIB

Chime History

Westminster Chimes

Arranged from George Fredrick Handel’s aria, “I Know That My Redeemer Liveth,” and best known as the chimes of Big Ben, this four-bell chime is the most widely used chime in modern clocks.

Hour Chime

1/4 Hour Chime

1/2 Hour Chime

3/4 Hour Chime

Whittington Chimes

These chimes were made famous by a person rather than their location of St. Mary Le Bow in Cheapside, London. One day, a penniless boy named Dick Whittington heard them as he ran away to escape drudgery as an ill-treated houseboy. The chimes seemed to call him back with promises of success. He returned and persisted; later becoming Lord Mayor of London.

1/4 Hour Chime

1/2 Hour Chime

3/4 Hour Chime

Hour Chime

St. Michael’s Chimes

Although the bells for the chime were cast in London, they were installed in St. Michael’s Church in Charleston, SC, in 1764. During the Revolutionary War, the city was captured by the British and the bells returned to England. After the war, a London merchant returned the bells to Charleston. In 1823, cracks were discovered in the bells and they were returned to England to be recast. During the Civil War, the bells were sent to Columbia for safekeeping, but were damaged in a fire set by Sherman’s army. After the war, the bells made a third trip to England for restoration; and were reinstalled in the St. Michael’s Church steeple in 1867, where they remain to this day.

1/4 Hour Chime

1/2 Hour Chime

3/4 Hour Chime

Hour Chime

BILLIB

Ave Maria Chimes*

In 1825 Franz Schubert wrote seven songs based on the poem, “The Lady of the Lake,” by Sir Walter Scott. The poem is set in the woods of Scotland in the early 1500’s, where Ellen Douglas lived in hiding. King James V had banished the entire Douglas clan because Archibald Douglas, Earl of Angus, had imprisoned the child king during the early years of his reign. The song was Ellen’s prayer for safety for herself and her father as they hid in the woods. It has become part of the standard repertoire for sopranos under the title “Ave Maria.”

Hour Chime

Beethoven Chimes*

Ludwig van Beethoven’s Ninth Symphony was first performed in Vienna in the year 1824. This was Beethoven’s last major composition. His use of vocal and instrumental music was revolutionary.

In 1907, Henry Van Dyke used a theme from the fourth movement in Beethoven’s hymn, “Joyful We Adore Thee.” This chime encompasses the first eight measures of this famous hymn tune.

Hour Chime

Westminster Chimes*

Hour Chime

*NOTE: Clocks with Ave Maria, Beethoven and Westminster combinations only chime on the hour. These clocks strike one cord for each 15 minute interval after the hour.

CARE OF YOUR BILLIB CLOCK

Replacing Suspension Spring

If the suspension spring is damaged, it may be replaced. Remove the pendulum and unscrew the small knurled bolt in the suspension post which holds the spring in position. Hook the pendulum hanger to the new spring and insert the spring into the suspension post. Align the hole in the top portion of the spring with the hole in the suspension post and replace the knurled bolt (Fig. 21).

Moving Your Clock

Before moving clock, always remove weights and pendulum, if your clock has them. If the clock is to be transported by vehicle, all parts must be protected by the original packaging or similar materials.

Replacement Parts

Parts may be ordered through your local BilliB Dealer. Identify the clock model, movement and registration numbers, in order to properly identify the part.

Care of the Movement

Dust is the enemy of all precision machined parts. Protect your clock from dust, chemical vapours and areas of constant vibration.

Your clock movement should be oiled by a qualified repair person approximately every five years, and cleaned at regular intervals as recommended by the repair person. Only the finest clock oil should be used. Oil should never be randomly sprayed or applied on the mechanism.

Fig. 21

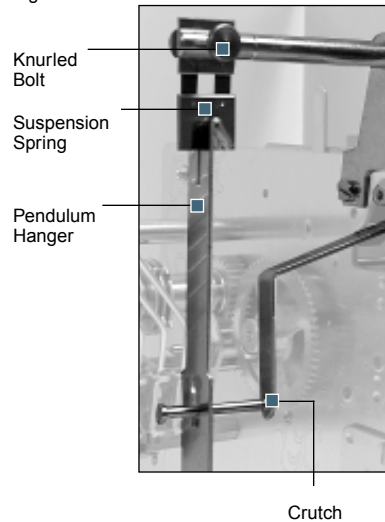

Care of Clock's Wood Finish

BilliB Clock's beautiful hand-polished finish will last for generations. Regular dusting with a soft, lint-free cloth such as cotton, flannel, terrycloth or cheesecloth will help maintain the wood's original luster. Using a slightly dampened cloth will cut down on friction, avoid scratches, and help reduce static electricity that attracts and holds dust.

The beauty of the clock case can be maintained by periodically using a self-cleaning furniture polish. Soap and water is not a thorough cleaner for wood products. Self-cleaning furniture polishes contain both wax and solvents which maintain luster and provide adequate cleaning under most circumstances. If a more thorough cleaning is necessary, use odourless mineral spirits.

Always protect your BilliB Clock from conditions of excessive heat, cold, dampness and strong sunlight.

In the event of small marks or scratches, use a touch-up stick or scratch remover, available from most paint stores or call a professional furniture repair person.

Care of Brass Parts

The fine brass accents of your BilliB Clock should only be handled with soft cotton gloves or a soft cloth. Dust with a fine, soft, clean cloth.

NEVER use an abrasive cleanser, permanent damage will result from its use.

Cleaning Glass

Avoid getting cleaning products on brass surfaces. Spray glass cleaner on a soft cloth and then wipe glass surfaces. Never spray directly onto the cabinet or brass finish (Fig. 24).

Fig. 24



Always spray cleaning products on soft cloth, not directly on surface of clock.

Troubleshooting

If your clock will not run ...

1. **Has all the packing material been removed? Pg. 3**
2. **Restart & regulate clock. Pg. 9**
3. **Check for proper weight placement. Pg. 5**
4. **Is the pendulum hitting the weights or chime rods?**
 Make sure your clock is hanging straight and level. If your clock is set on thick carpet you can replace the levelling feet on the clock with ¼"-20 stove bolts 2 inches long, obtained from your local hardware store. These will set deeper into the nap of the carpet and add stability to the clock.
 Adjust chime rods. Pgs. 6 & 7
5. **Check the indexing spring of the moon dial.**
 Look through the left upper side door of the clock. The long strip spring on the back of the dial should rest on the edge of the moon disk. If it has slipped in front or behind the moon disk, replace it on top of the teeth (Fig. 25).
6. **Have you checked the hand clearance?**
 Don't let the hour hand hit the second hand between 11:00 and 1:00. If the second hand rubs the dial face, it can be pulled out slightly. If the hour hand rubs against the back of the minute hand, it can be pushed closer to the dial face. With your thumb on the centre portion of the hand, push towards the dial.
7. **Check the suspension spring.**
 If damaged, replace. Pg. 12
8. **Make sure the pendulum hanger is in the centre of the crutch (Fig. 26).**
 If it is not, check the level of your clock from front to back. If the hanger still rubs the front or back of the crutch, you may have to slightly bend the crutch to compensate.

Fig. 25



Indexing Spring.

Fig. 26



Pendulum Hanger
Crutch

Troubleshooting

If your clock will not chime or strike properly ...

1. **Check items #1, #3, and #5 under the heading, "If Your Clock Will Not Run." Pg. 14**
2. **Check Selection Lever.**
 Is your selection lever in the silent position, or halfway between two chime positions? Pg. 6
3. **Check your hammer adjustment.**
 Make sure no two hammers touch. Pg. 6, 7
4. **To correct the hour strike adjustment, try the following:**
 Move the minute hand around to the hour let the clock chime and strike.
 Count the number of hour strikes and move the hour hand to that hour. The hour hand is friction fit and will move easily.
 Example: if the clock strikes 4 times and the hour hand points to 5 o'clock, then move the hour hand to the number 4 on the dial. The number of strikes and the time on the dial will now match.
 Now, to set the clock to the correct time, move the minute hand to the correct time on the dial.

If the pendulum is not swinging straight...

1. **Adjust the pendulum**
 Hold the middle of the pendulum with one hand and with the other hand, turn or twist the pendulum just above the lyre, so it is straight with the front of the case. In most cases ¼" is all that is needed to obtain a straight swing of the pendulum.

If the weights do not descend evenly...

1. **Check the silent or night-off selection**
 On some movements, if the outside weights remain stationary and the middle weight descends, it is because the clock is in the silent or night-off mode. If the clock is more than a couple years old, it could be an indication that the movement needs oil.

GUARANTEE

Thank you for purchasing a clock designed and crafted for BilliB Sales (UK) Ltd.

For many years BilliB has offered a select array of clocks that are not only treasures to behold, they are heirlooms to be shared from one generation to the next.

Each BilliB original reflects a hallmark of craftsmanship that is unparalleled.

BilliB warrants the actual clock movement for a period of two years from the date of consumer purchase, provided the clock has been set-up and maintained following the directions furnished with the clock. The warranty is limited to the original consumer purchasing the clock, the warranty is not transferable.

This warranty does not cover set-up costs (including hammer and hand adjustment or time regulation as described in the Instruction and Care manual), lubrication, broken suspension springs, unauthorized repairs, clocks not purchased from an authorized BilliB Dealer, or clocks that have been reshipped.

This warranty does not apply to damage to the clock due to negligence, modification (such as switching weights, pendulums, or dials) or to other causes unrelated to defective material or workmanship.

For proper operation and continued enjoyment of your clock, please follow the installation and care recommendations found with your instructions.

Wood products may have slight variances in colour due to wood grain and natural characteristics of wood material. Shrinkage and expansion of wood solids and veneers may occur with changes in temperature, humidity and altitude. These are normal characteristics of wood furniture products and are not covered under warranty.

Consistency in room temperature and humidity is recommended; avoid exposing the clock to extreme changes in temperature, which may cause fractures in the finish, joints, or veneers. Clocks exposed to extreme conditions (very dry or dusty, very humid, or ocean front) will require more frequent service to the mechanism.

Procedure to Follow when there is a Defect or other Problem

- Contact the Authorized BilliB Dealer from whom you purchased the clock, provide the registration number and nature of the problem.
- All requests for service, parts, or returns must be presented to BilliB by an Authorized BilliB Dealer. **<ca Y**

Home Delivery - Products are picked up at BilliB, and signed for in good condition by the freight carrier. Damage caused by the carrier in transit between BilliB and the dealer/consumer is not covered by the warranty. Freight damaged products must be inspected by the carrier within 3 days of delivery by the carrier. In the event of freight damage or loss, a claim is to be filed by the consignee (person receiving the clock) with the freight carrier.

All expressed and implied warranties, including implied warranties of merchantability and fitness for purpose, are limited to the time periods set forth above.

BILLIB

MY CLOCKS HISTORY

MODEL	
1ST OWNER	
2ND OWNER	

BILLIB

Record of Service

Date of Purchase:	Place of Purchase:
Date of Service:	Service Performed By:
Description of Service:	
Date of Service:	Service Performed By:
Description of Service:	
Date of Service:	Service Performed By:
Description of Service:	
Date of Service:	Service Performed By:
Description of Service:	

clocks

BILLIB SALES (UK) LTD
NORWICH ROAD
BOURNEMOUTH
BH2 5QZ

WWW.BILLIB.CO.UK